

SOLAR

Die No.: 3108

Wt.: 0.450 - 0.500 (KG/M)

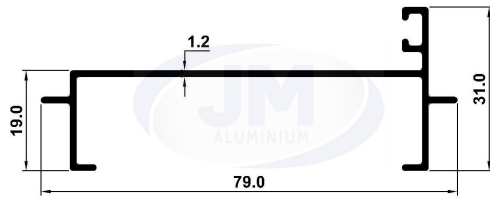

Die No.: 2146

Wt.: 0.575-0.675 (KG/M)

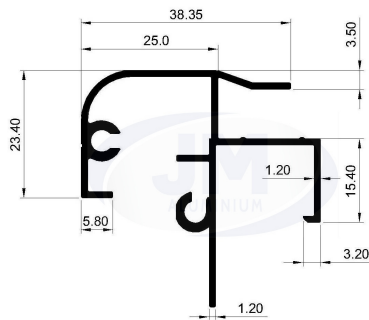

Die No.: 32019

Wt.: 0.160 - 0.190 (KG/M)

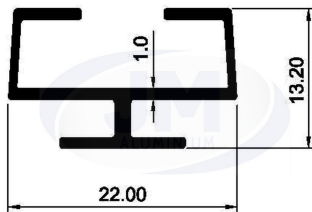

Die No.: 2123

Wt.: 0.465-0.495 (KG/M)

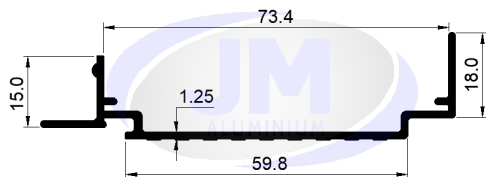

Solar Water Heater

Die No.: 2135

Wt.: 1.040-1.100 (KG/M)

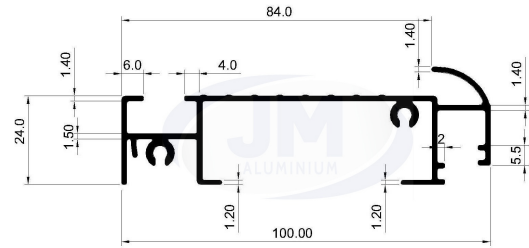

Die No.: 32011

Wt.: 0.150 - 0.190 (KG/M)

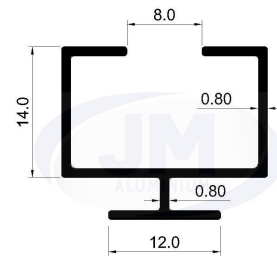

Die No.: 32022

Wt.: 0.650 - 0.760 (KG/M)

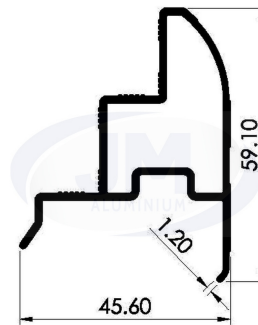

Die No.: 2128

Wt.: 0.630-0.660 (KG/M)

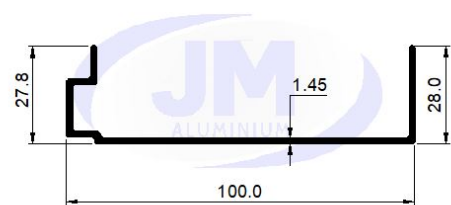

SOLAR

Die No.: 2132

Wt.: 0.510-0.540 (KG/M)

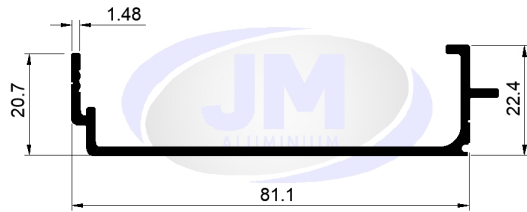

Die No.: 32029

Wt.: 0.450-0.550 (KG/M)

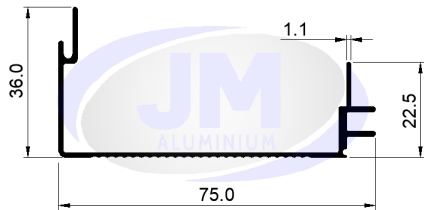

Die No.: 32030

Wt.: 0.640-0.750 (KG/M)

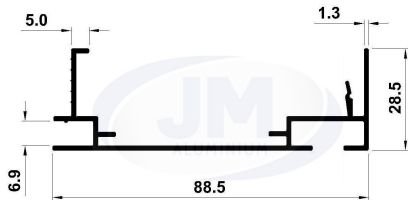

Die No.: 2144

Wt.: 0.380-0.430 (KG/M)

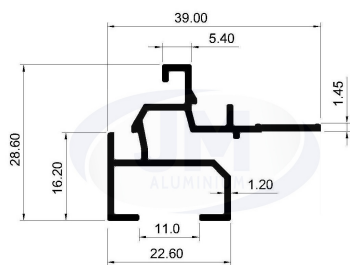

Solar Water Heater

Die No.: 32031

Wt.: 0.130-0.160 (KG/M)

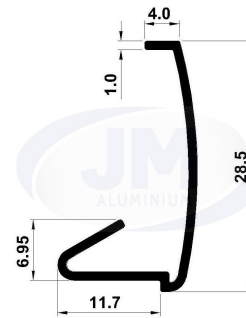

Die No.: 23014

Wt.: 0.160-0.190 (KG/M)

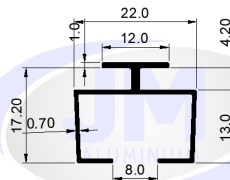

Die No.: 2143

Wt.: 0.250-0.280 (KG/M)

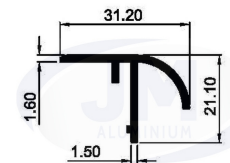

Die No.: 32028

Wt.: 0.650 - 0.750 (KG/M)

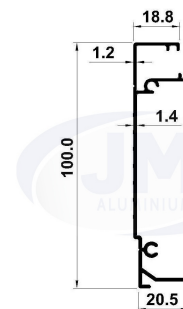

SOLAR

Solar Water Heater

